

10% of Actual Size
Screen Print

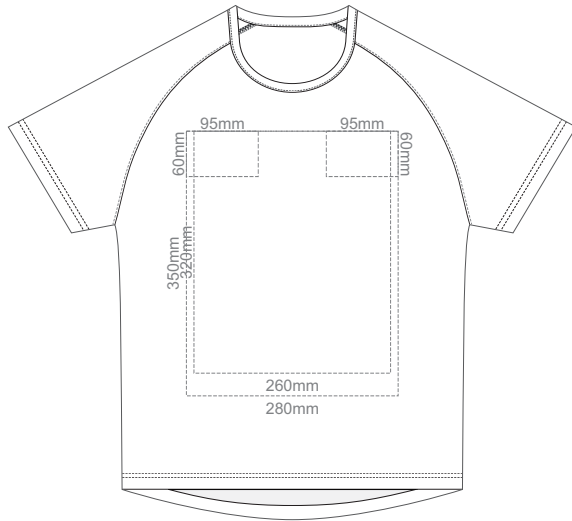

FRONT

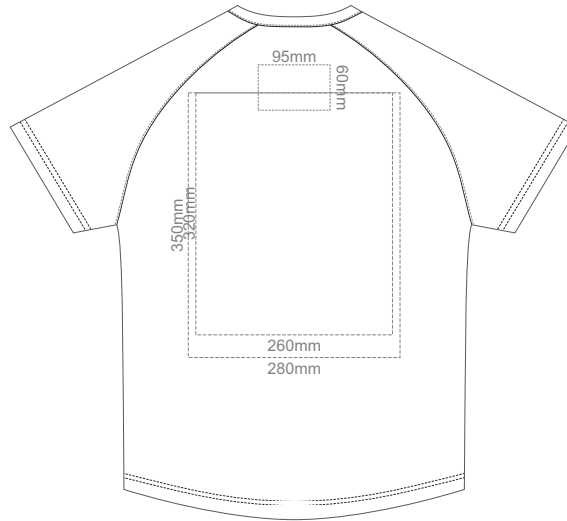

BACK

10% of Actual Size
Screen Print

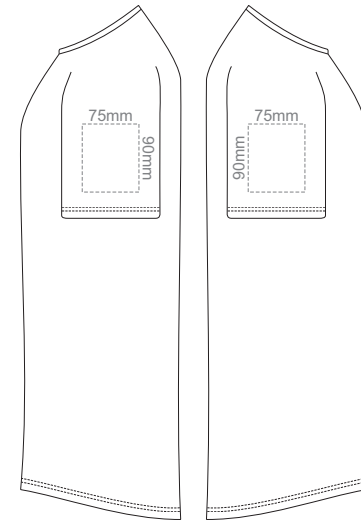

LEFT SLEEVE

RIGHT SLEEVE



MEN'S XS

10% of Actual Size
Screen Print

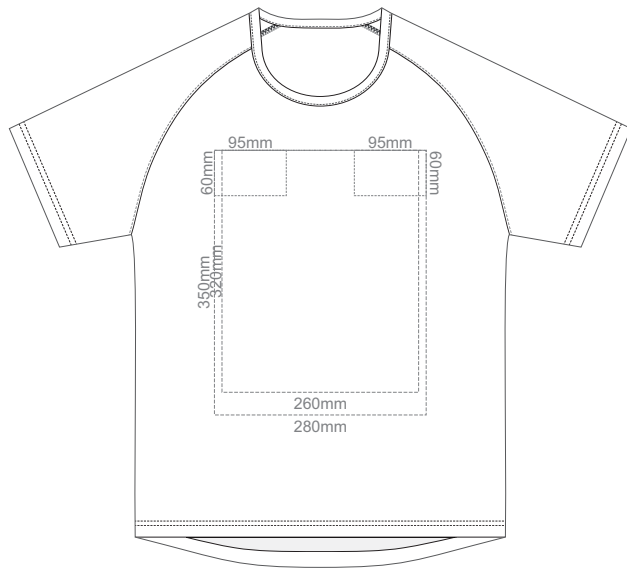

FRONT

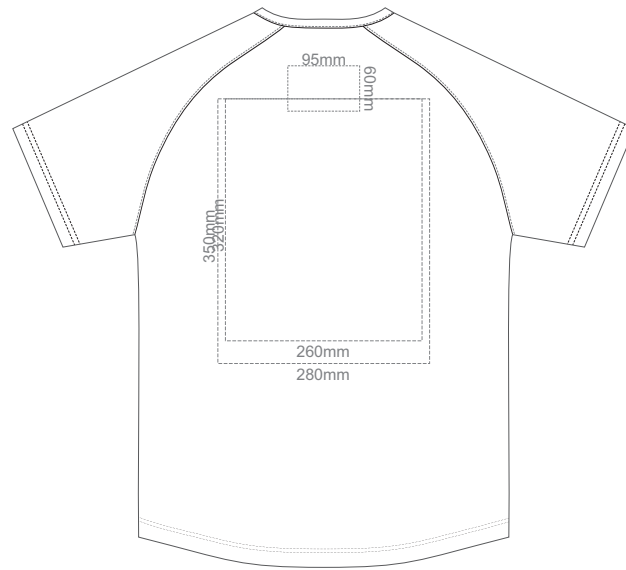

BACK

10% of Actual Size
Screen Print

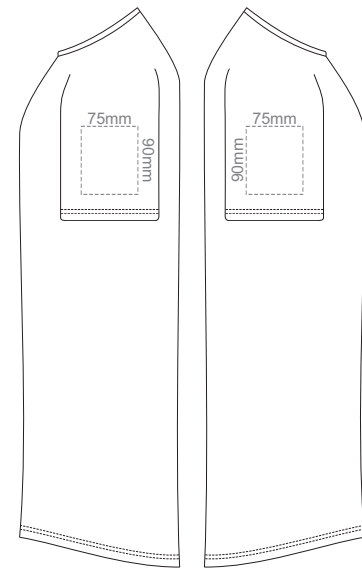

LEFT SLEEVE

RIGHT SLEEVE



MEN'S S

10% of Actual Size
Screen Print

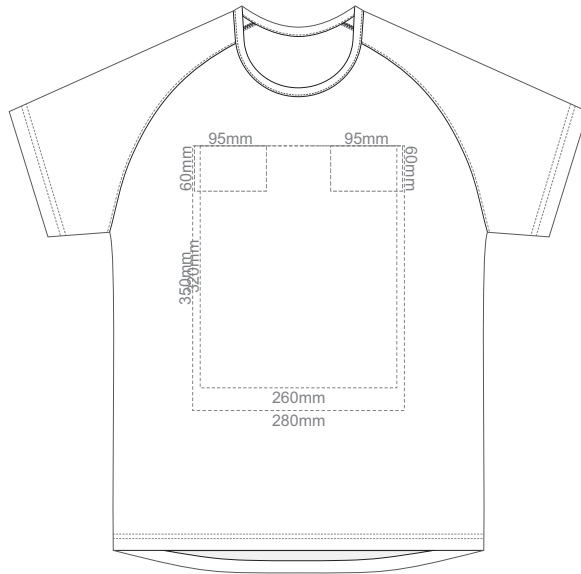

FRONT

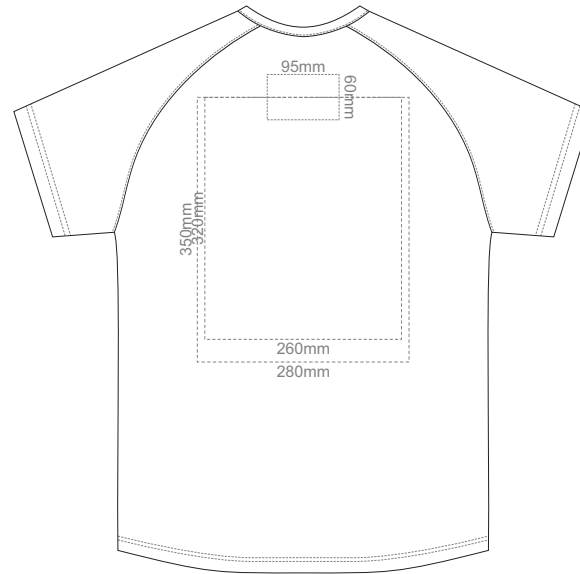

BACK

10% of Actual Size
Screen Print

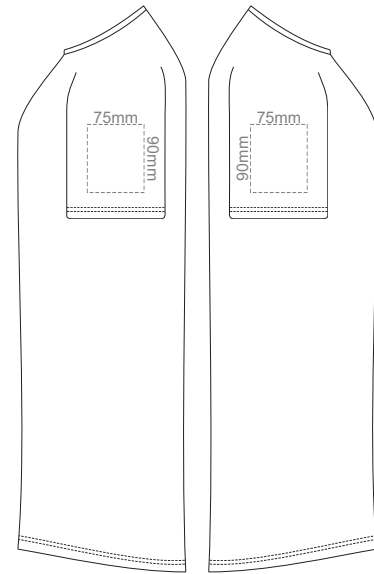

LEFT SLEEVE

RIGHT SLEEVE



MEN'S M

10% of Actual Size
Screen Print

10% of Actual Size
Screen Print

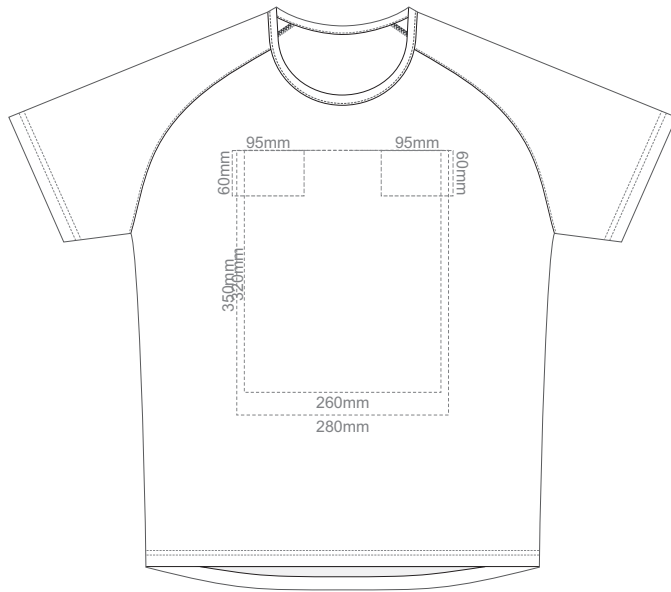

FRONT

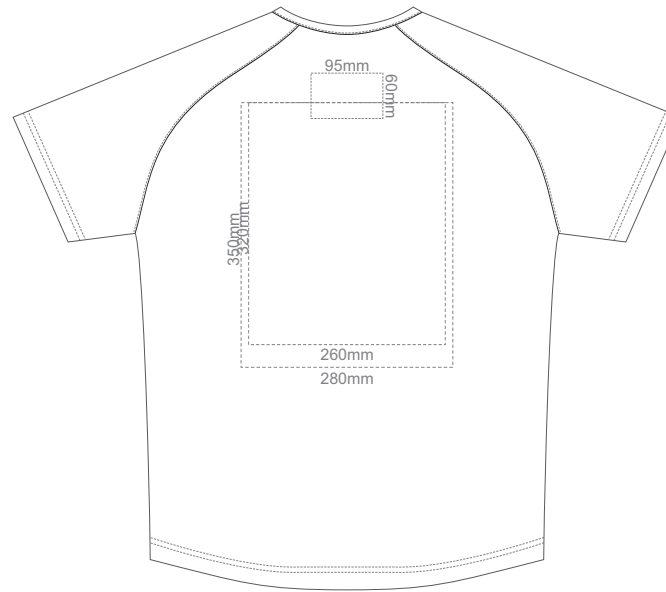

BACK

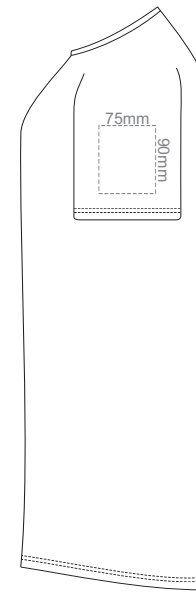

LEFT SLEEVE

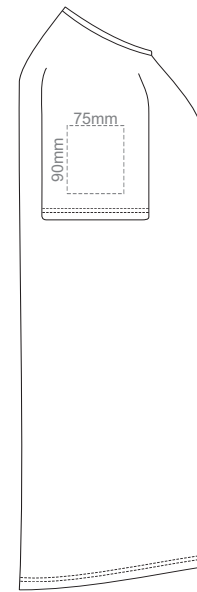

RIGHT SLEEVE



MEN'S L

10% of Actual Size
Screen Print

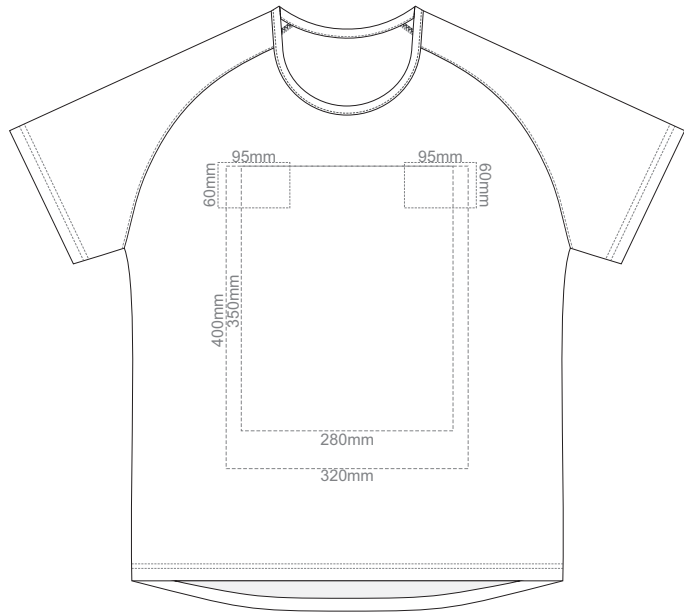

FRONT

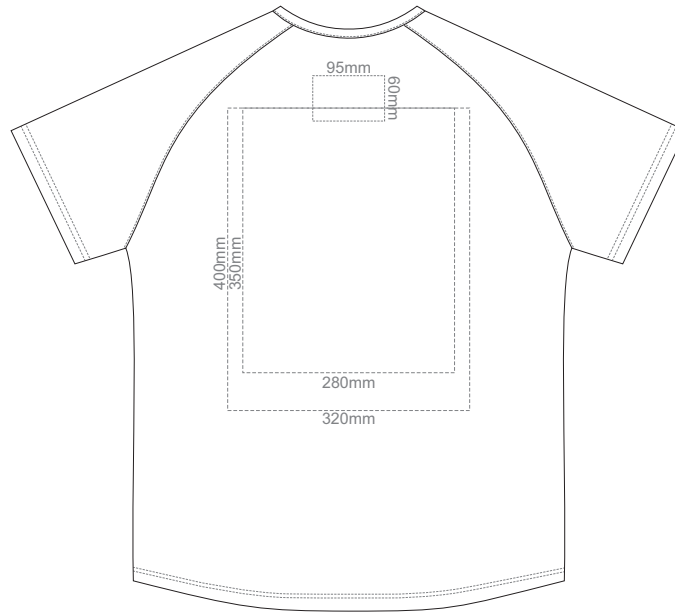

BACK

10% of Actual Size
Screen Print

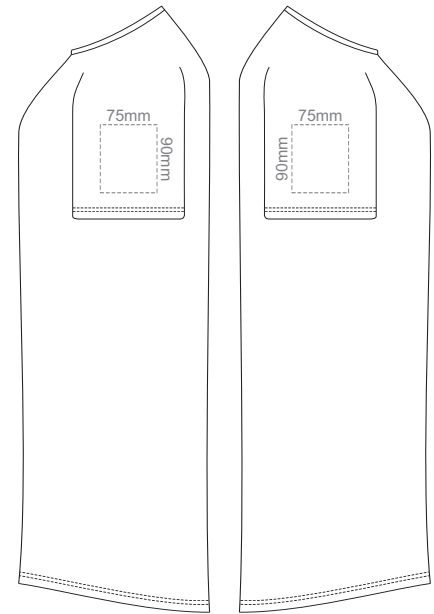

LEFT SLEEVE

RIGHT SLEEVE



MEN'S XL

10% of Actual Size
Screen Print

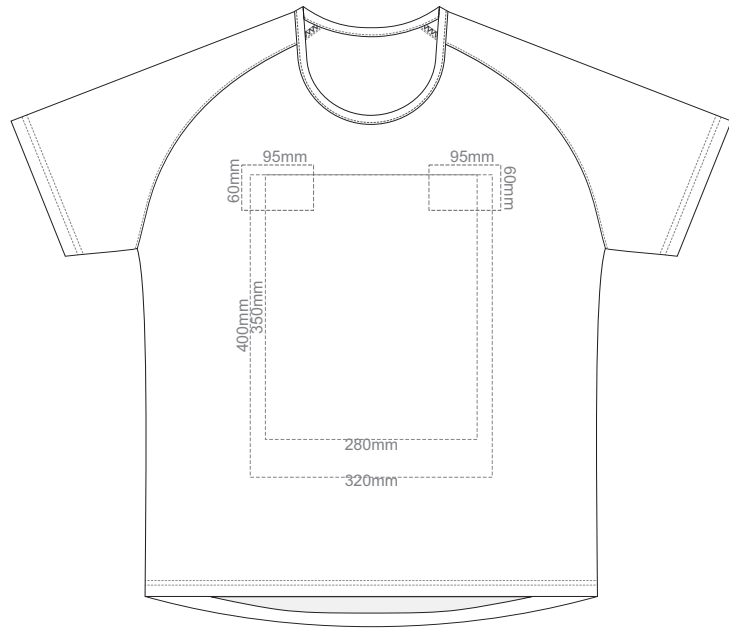

FRONT

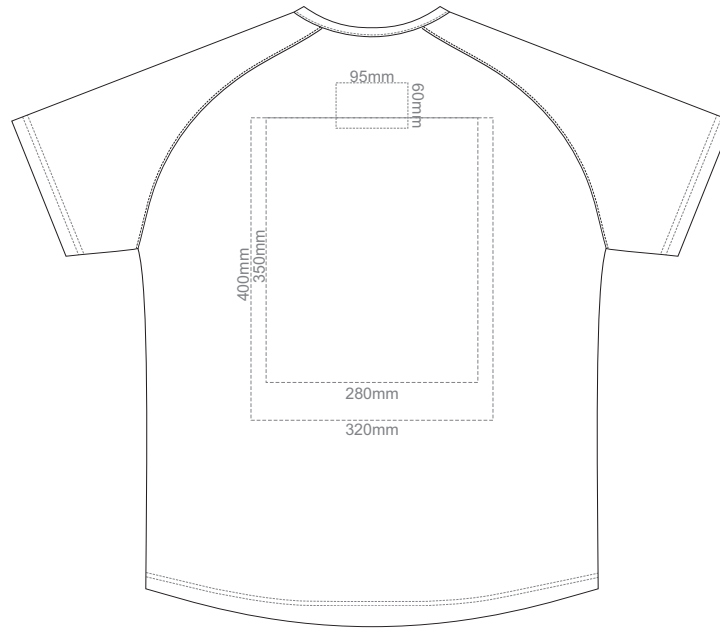

BACK

10% of Actual Size
Screen Print

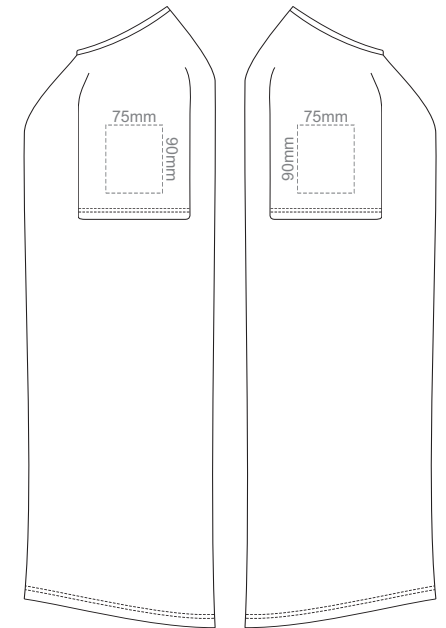

LEFT SLEEVE

RIGHT SLEEVE



MEN'S XXL

10% of Actual Size
Screen Print

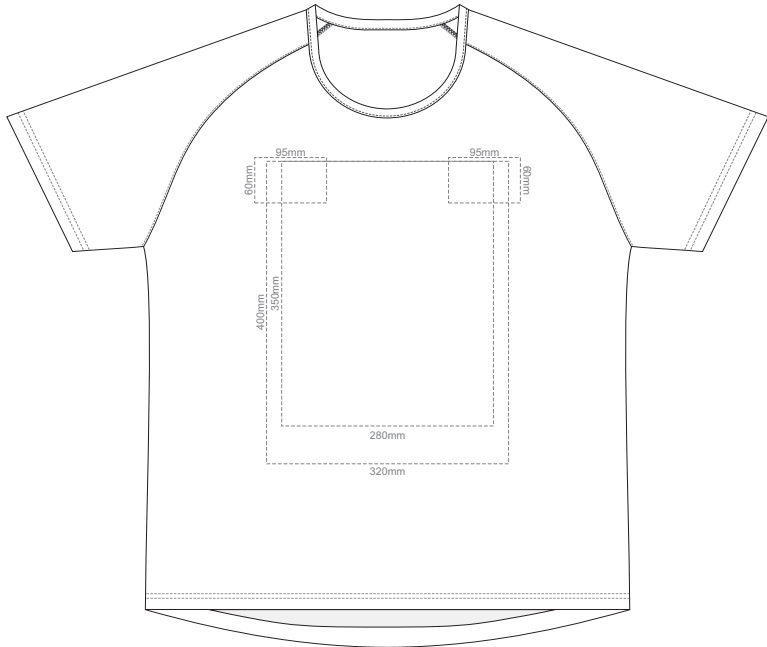

FRONT

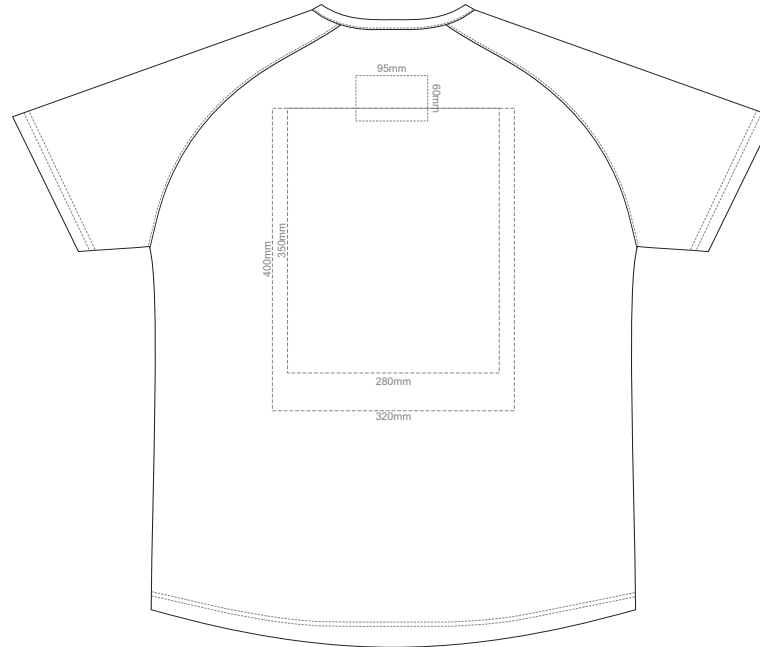

BACK

10% of Actual Size
Screen Print

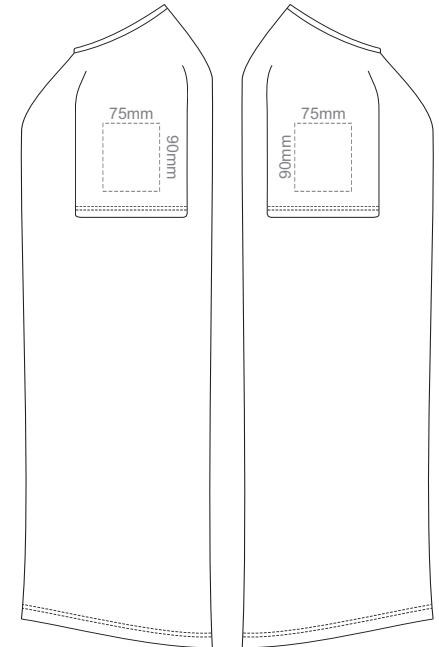

LEFT SLEEVE

RIGHT SLEEVE



MEN'S 3XL

10% of Actual Size
Colourflex Transfer

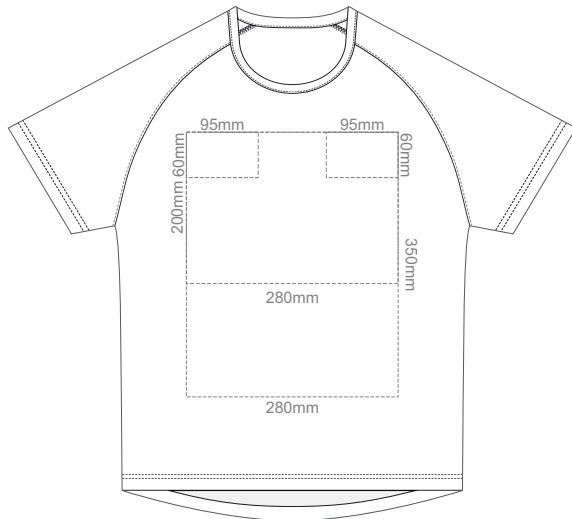

FRONT MEN'S EXTRA SMALL

Print area 280x200mm can be rotated to best suit.

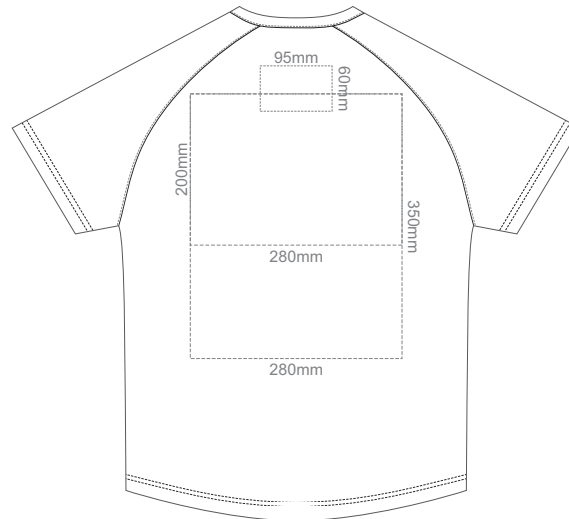

BACK MEN'S EXTRA SMALL

Print area 280x200mm can be rotated to best suit.

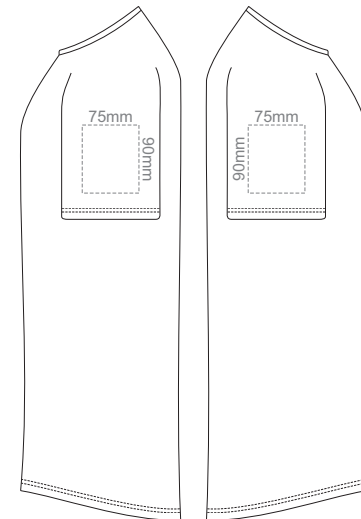

LEFT SLEEVE

RIGHT SLEEVE



MEN'S XS

10% of Actual Size
Colourflex Transfer

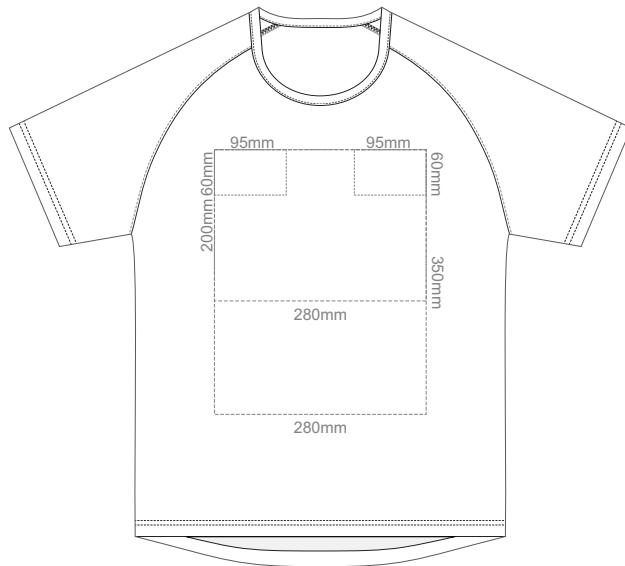

FRONT MEN'S SMALL

Print area 280x200mm can be rotated to best suit.

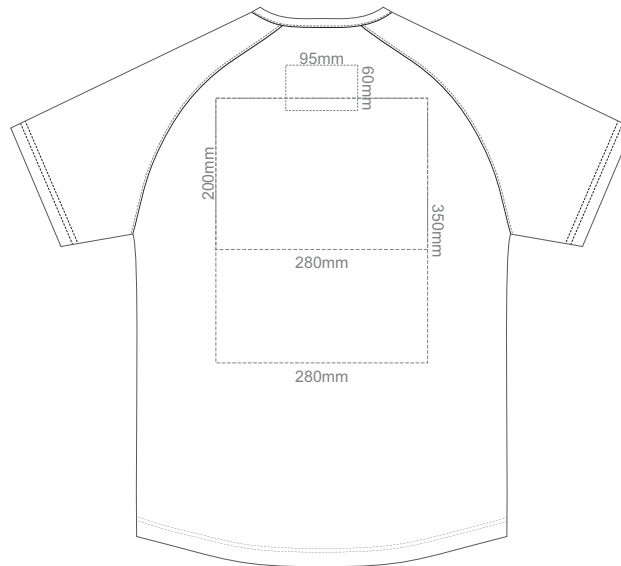

BACK MEN'S SMALL

Print area 280x200mm can be rotated to best suit.

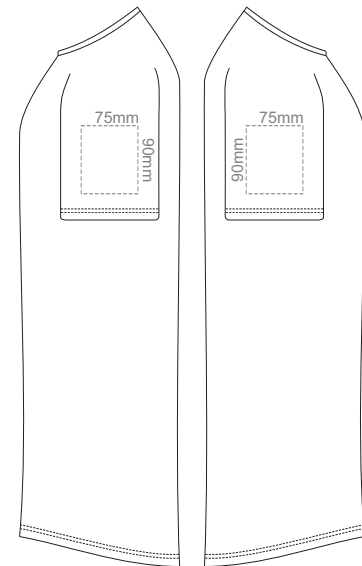

LEFT SLEEVE

RIGHT SLEEVE



MEN'S S

10% of Actual Size
Colourflex Transfer

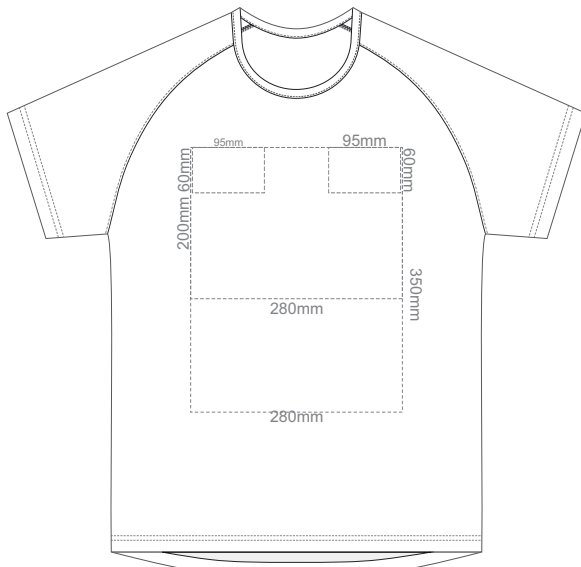

FRONT MEN'S MEDIUM

Print area 280x200mm can be rotated to best suit.

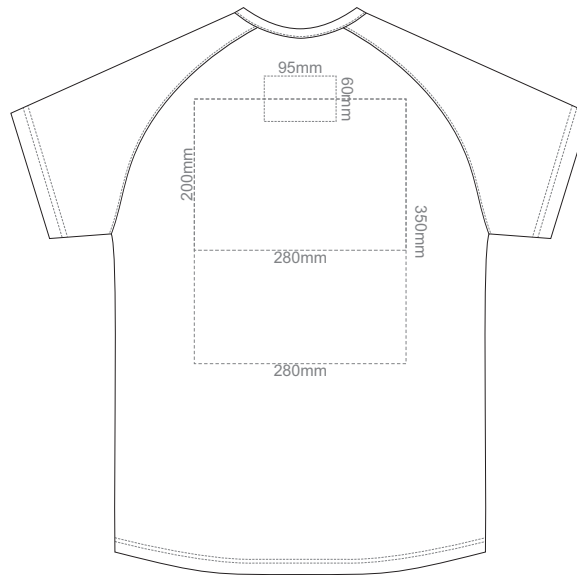

BACK MEN'S MEDIUM

Print area 280x200mm can be rotated to best suit.

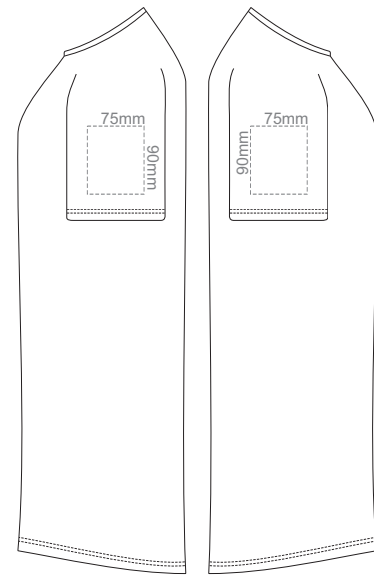

LEFT SLEEVE

RIGHT SLEEVE



MEN'S M

10% of Actual Size
Colourflex Transfer

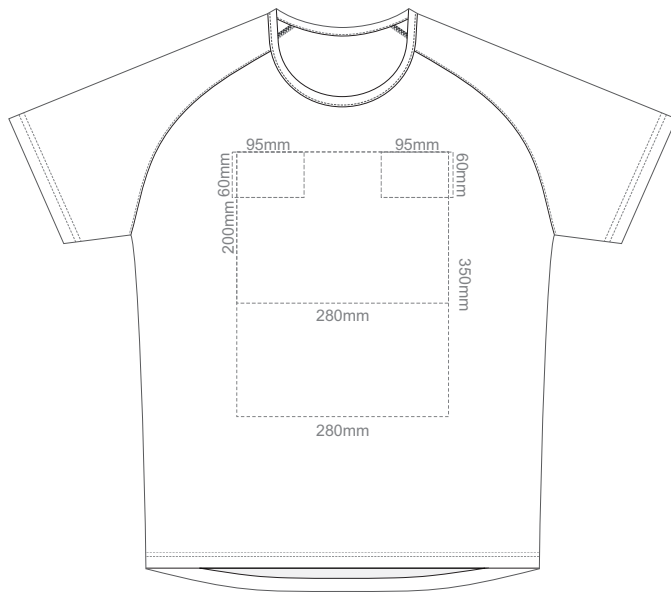

FRONT MEN'S LARGE

Print area 280x200mm can be rotated to best suit.

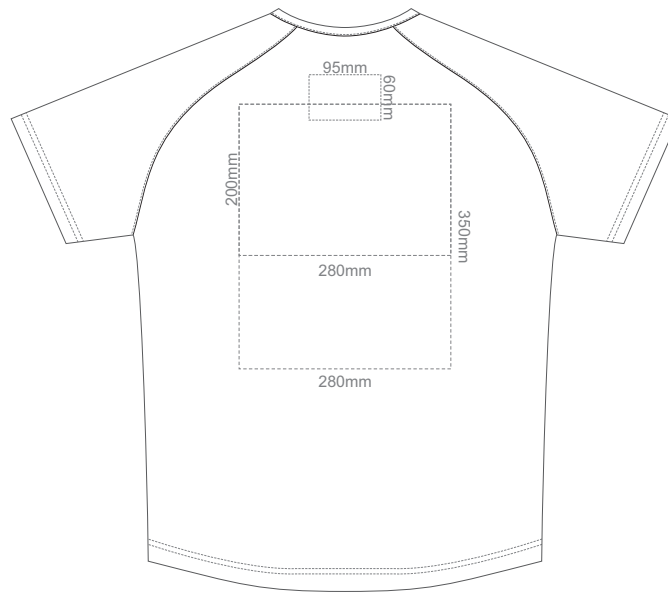

BACK MEN'S LARGE

Print area 280x200mm can be rotated to best suit.

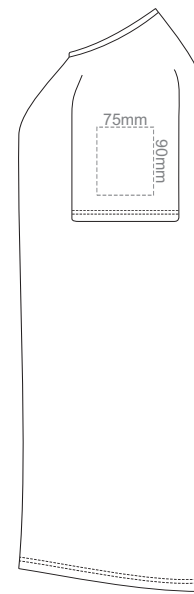

LEFT SLEEVE

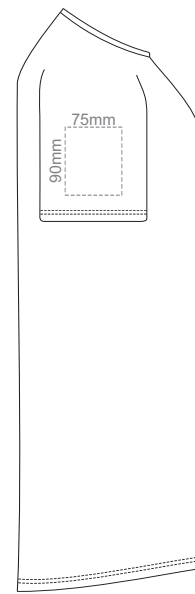

RIGHT SLEEVE



MEN'S L

10% of Actual Size
Colourflex Transfer

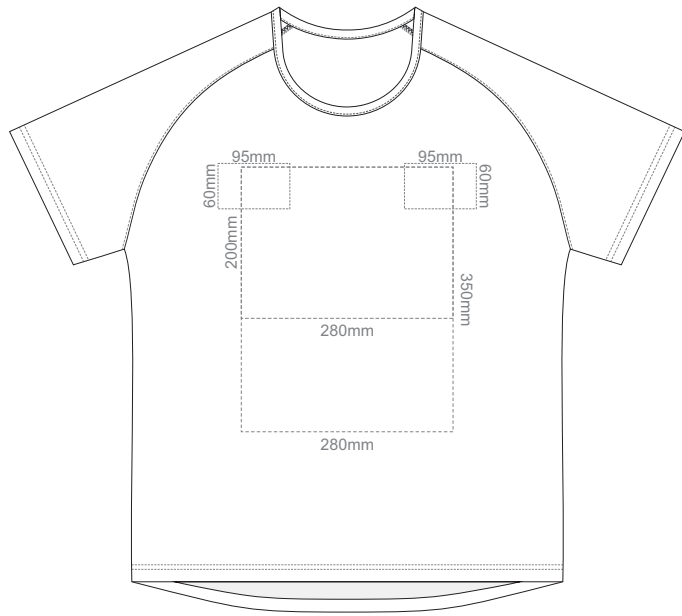

FRONT MEN'S XL

Print area 280x200mm can be rotated to best suit.

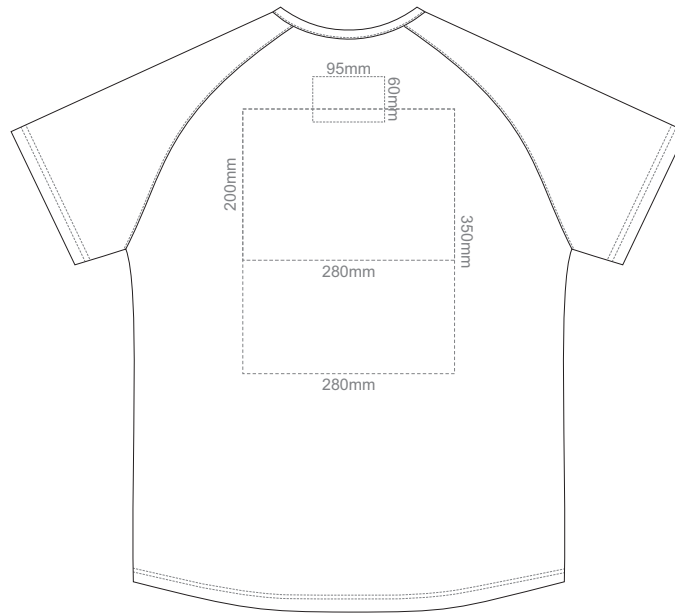

BACK MEN'S XL

Print area 280x200mm can be rotated to best suit.

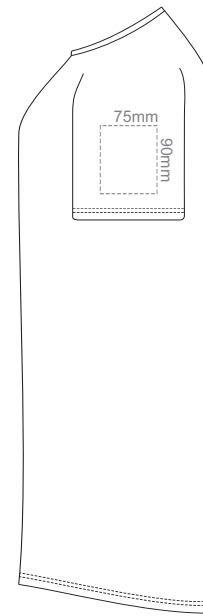

LEFT SLEEVE

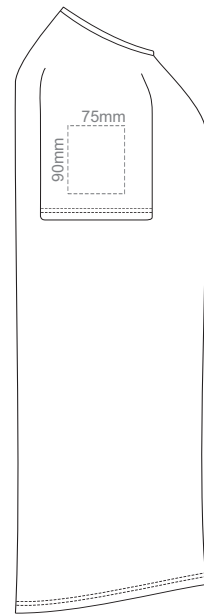

RIGHT SLEEVE



MEN'S XL

10% of Actual Size
Colourflex Transfer

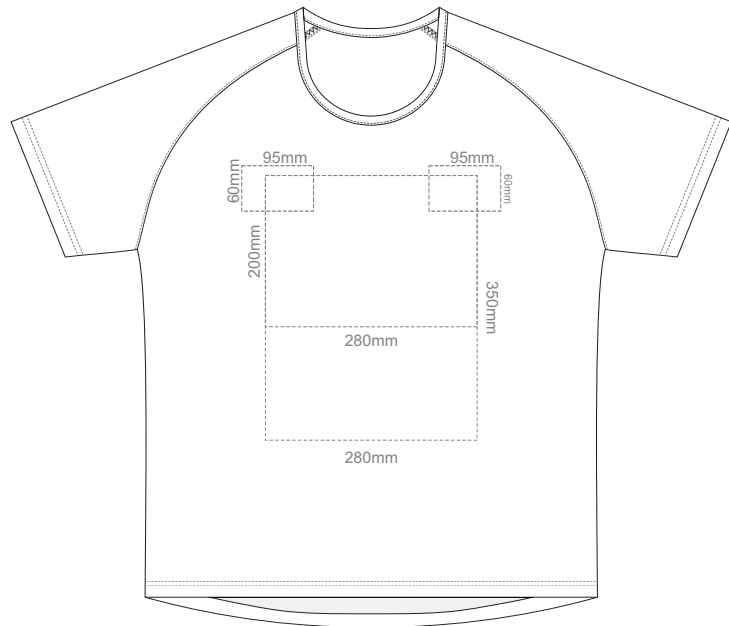

FRONT MEN'S 2XL

Print area 280x200mm can be rotated to best suit.

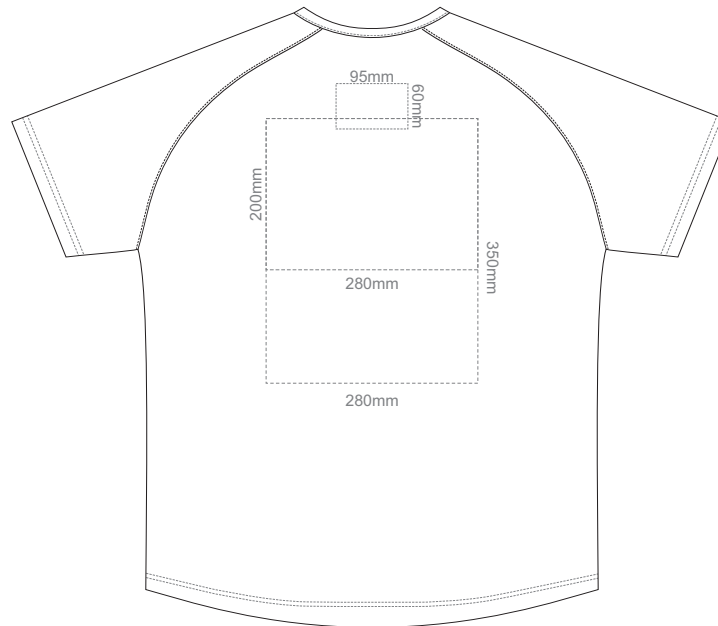

BACK MEN'S 2XL

Print area 280x200mm can be rotated to best suit.

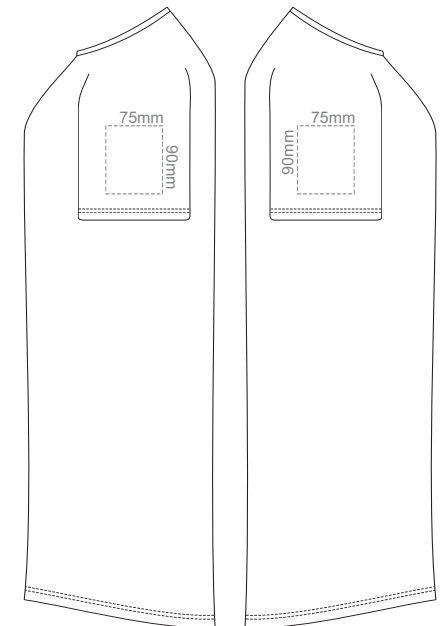

LEFT SLEEVE

RIGHT SLEEVE



MEN'S XXL

10% of Actual Size
Colourflex Transfer

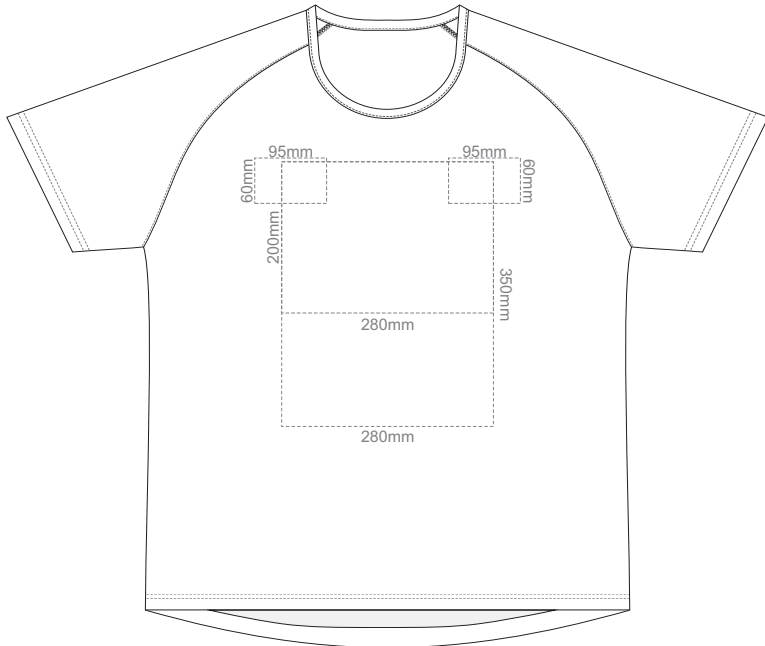

FRONT MEN'S 3XL

Print area 280x200mm can be rotated to best suit.

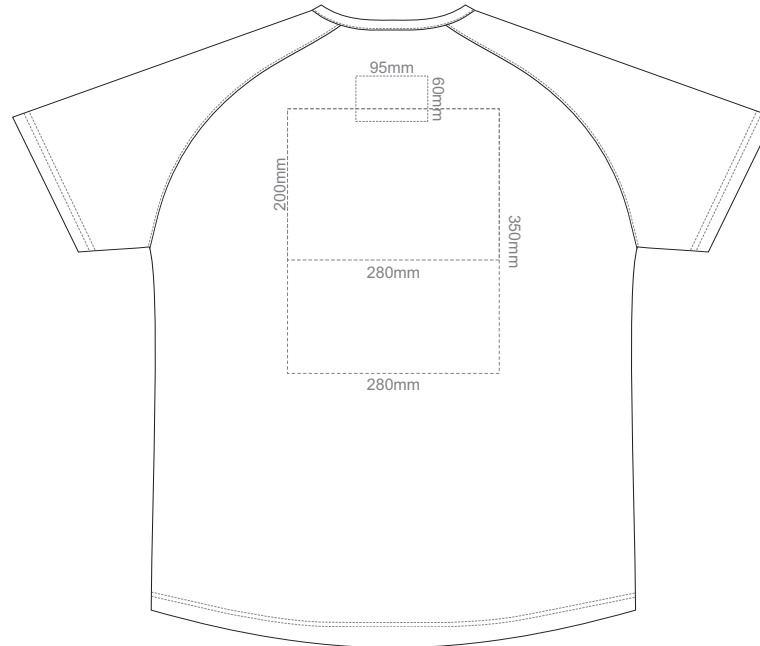

BACK MEN'S 3XL

Print area 280x200mm can be rotated to best suit.

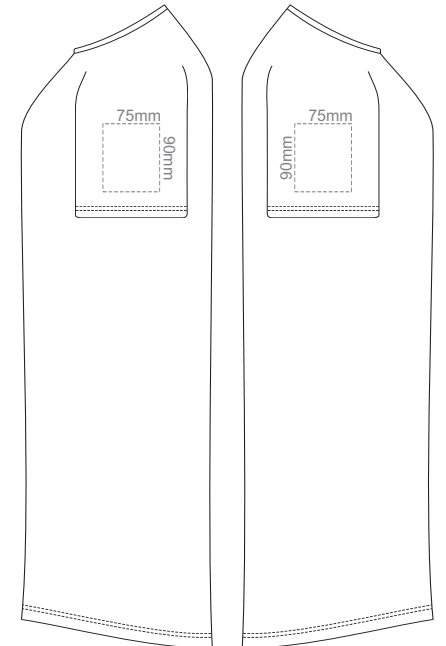

LEFT SLEEVE

RIGHT SLEEVE



MEN'S 3XL

10% of Actual Size
Embroidery

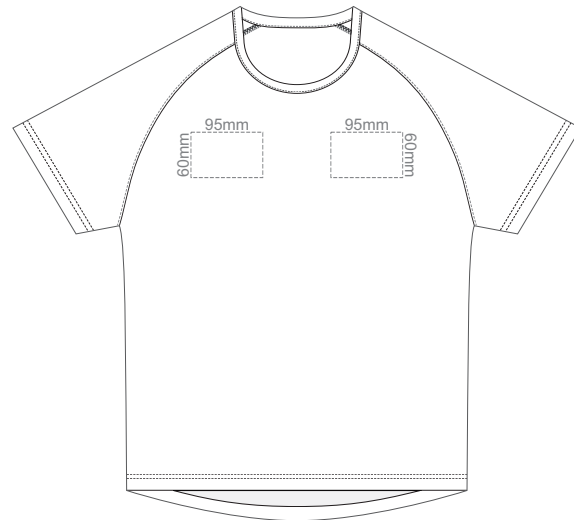

FRONT

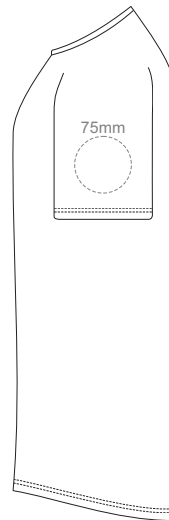

LEFT SLEEVE

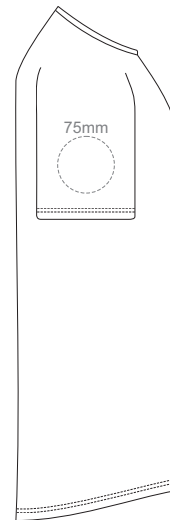

RIGHT SLEEVE



MEN'S XS

10% of Actual Size
Embroidery

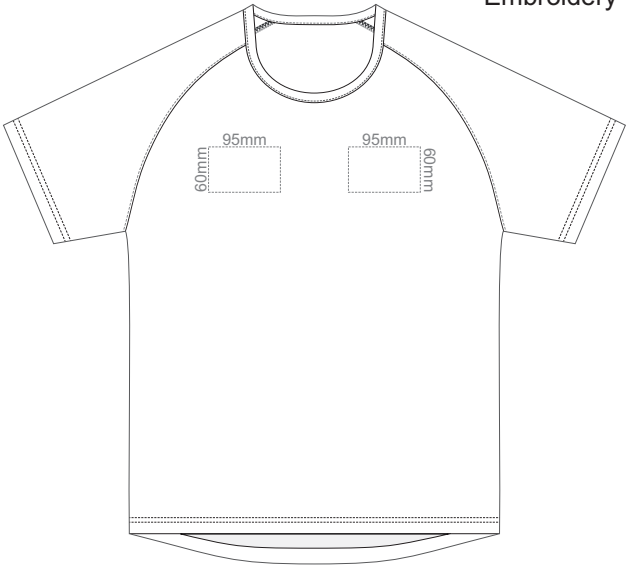

FRONT

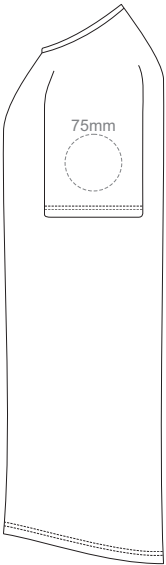

LEFT SLEEVE

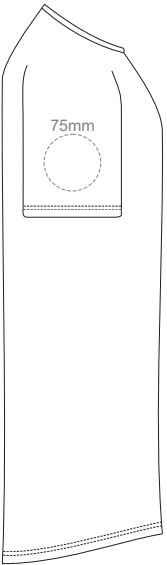

RIGHT SLEEVE



MEN'S S

10% of Actual Size
Embroidery

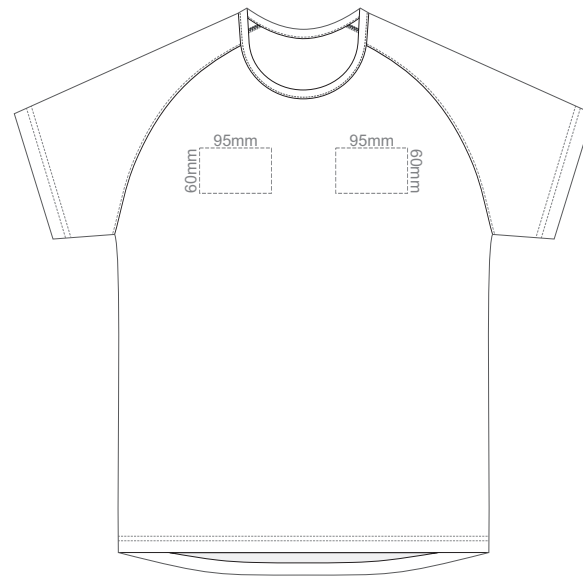

FRONT

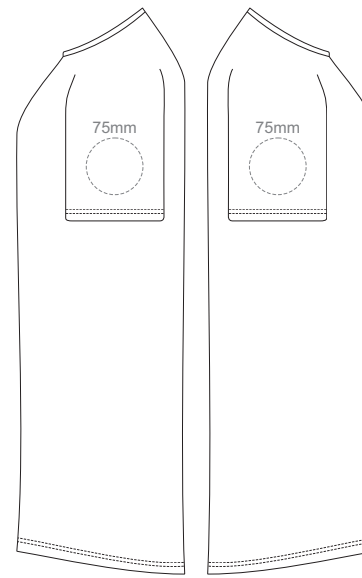

LEFT SLEEVE

RIGHT SLEEVE



MEN'S M

10% of Actual Size
Embroidery

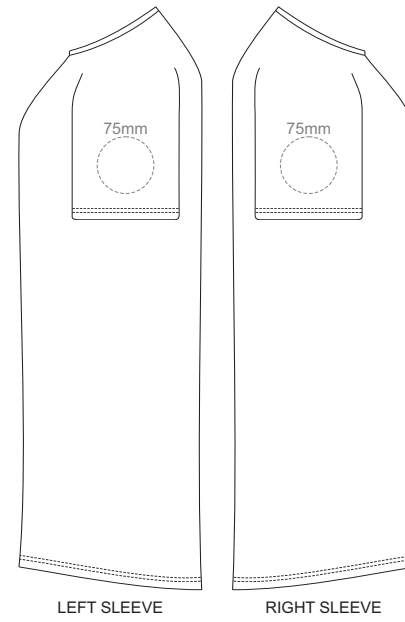
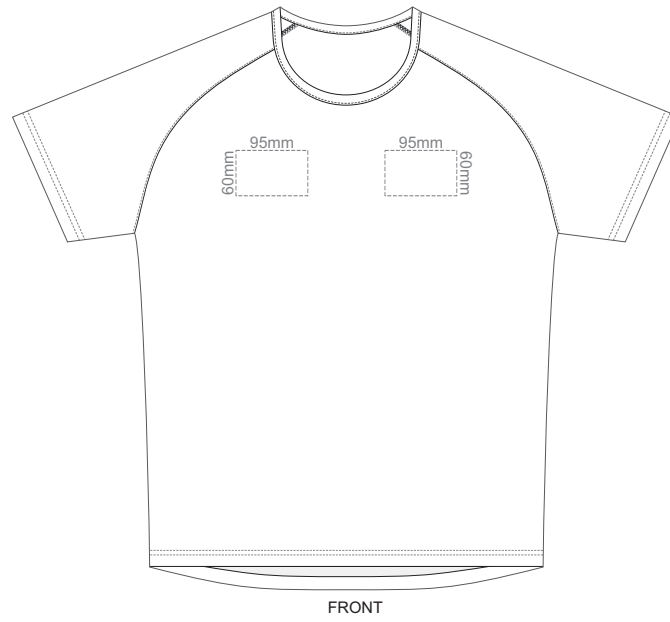

MEN'S L

10% of Actual Size
Embroidery

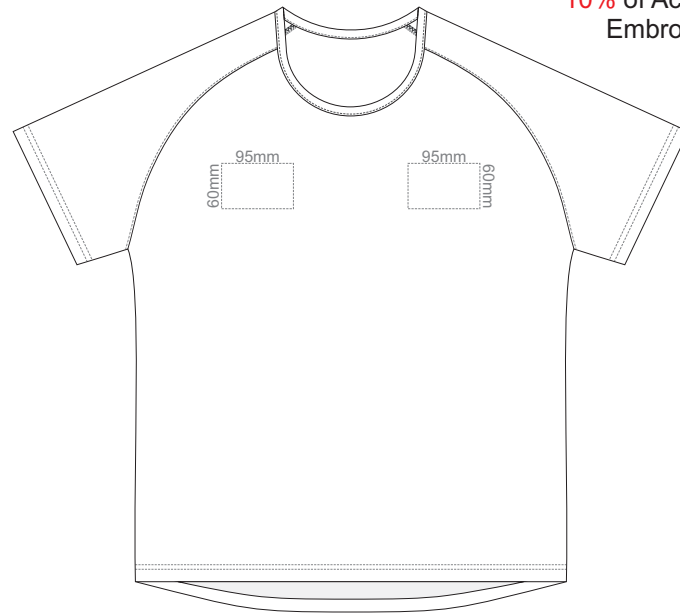

FRONT

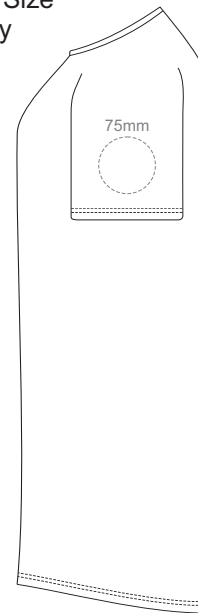

LEFT SLEEVE

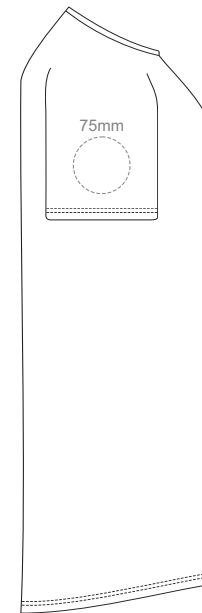

RIGHT SLEEVE



MEN'S XL

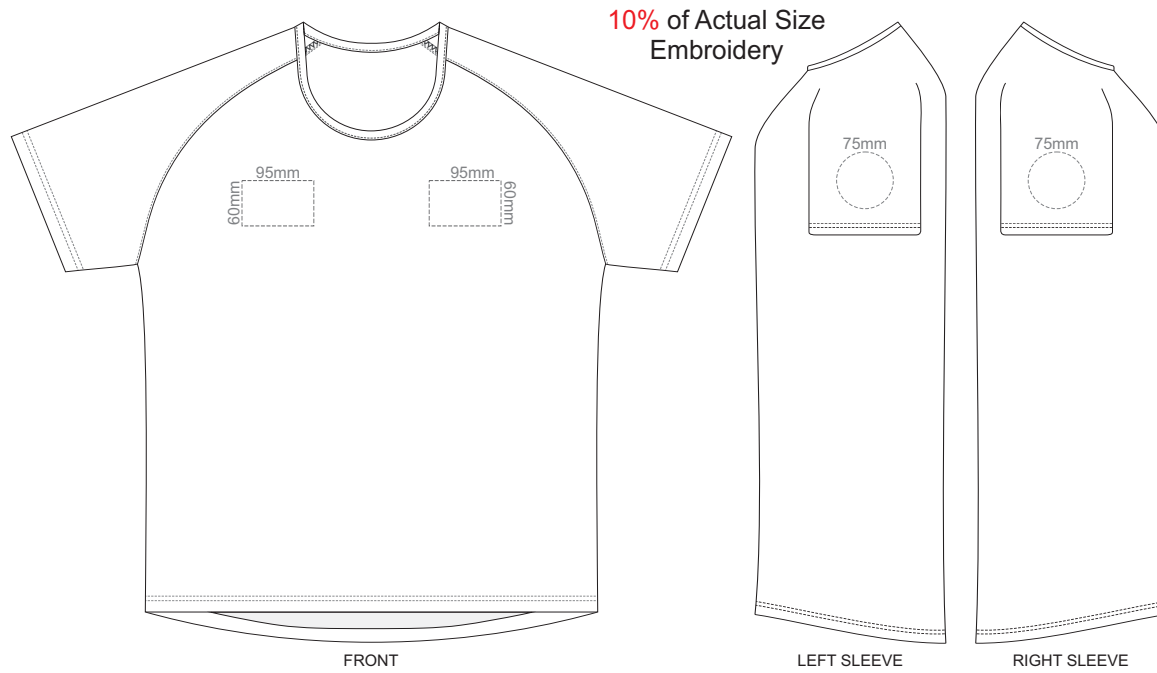

MEN'S XXL

10% of Actual Size
Embroidery



FRONT

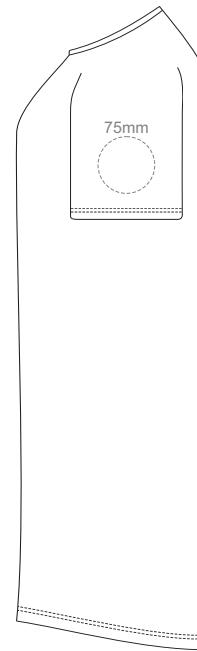

LEFT SLEEVE

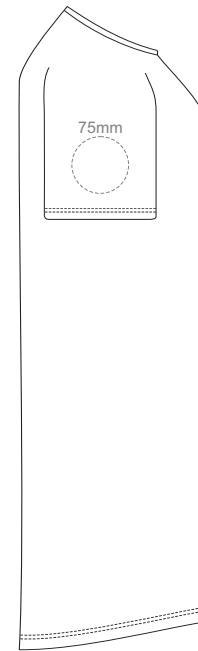

RIGHT SLEEVE



MEN'S 3XL